



# PRO line

Sophisticated inspection with future flexibility



**PRO H.160**  
**PRO H.225**

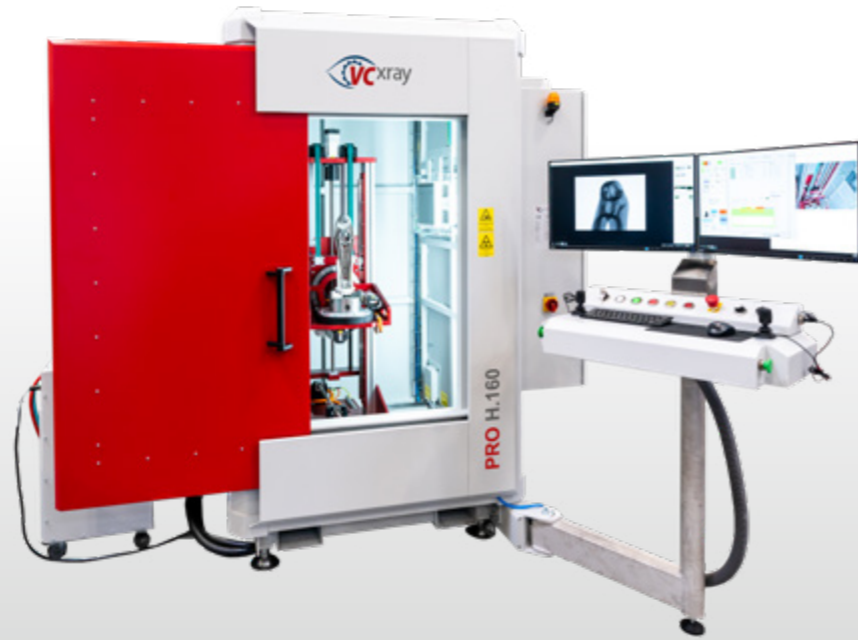

- ✓ Compact layout and small footprint
- ✓ Designed for small to medium sized parts like castings
- ✓ Widest variety of source and detectors
- ✓ Image enhancement and software tools designed for efficient use

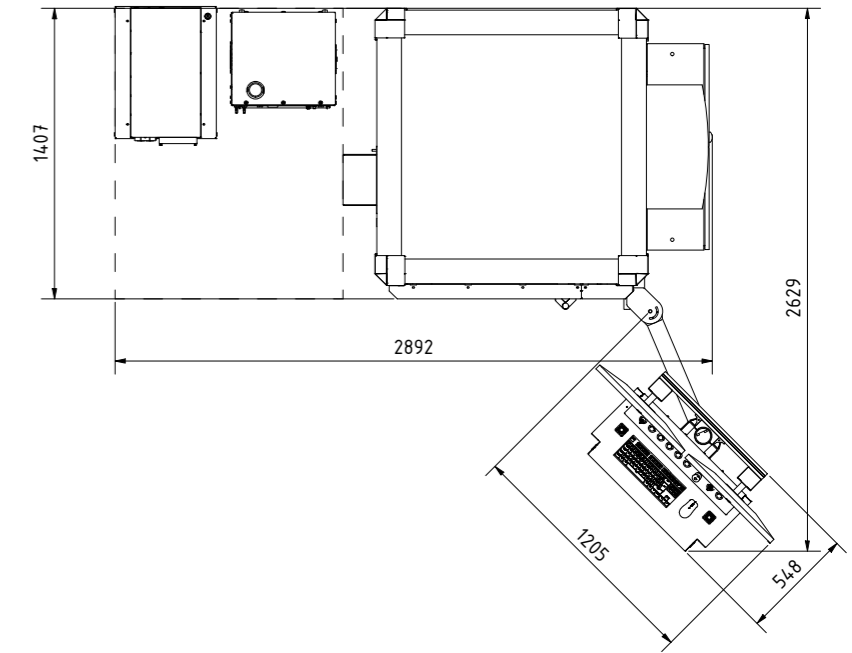

This universal X-ray cabinet provides the maximum flexibility for inspection of small to medium sized parts. The PRO H. series combines a compact footprint, the widest selection of imaging chains, and advanced options such as Computed Tomography (CT) and Automatic Defect Recognition (ADR). This leads to an ideally configured and scalable X-ray inspection system that is future-proof. The core of the system is VCxray's x.OS software ecosystem that includes VC.acquire and VC.review as standard features. Depending on the job-requirements, the system is available with 160 kV, 225 kV or microfocus x-ray tubes.



	<b>PRO H.160</b>	<b>PRO H.225</b>
<b>Cabinet dimensions*</b>	1485 x 1790 x 2310 mm	1485 x 1790 x 2310 mm
<b>Inspection envelope</b>	Ø 400 x 600 mm	Ø 400 x 600 mm
<b>Tilt axis (RX)**</b>	+20°/-0°*	+20°/-0°*
<b>Magnification value range</b>	1.2 - 2.6	1.2 - 2.6
<b>Max. part weight</b>	25 kg	25 kg
<b>Energy</b>	160 kV	225 kV

\*All dimensions are nominal and may vary depending on system configuration

\*\* Tilt is reduced continuously in the upper and lower positions and may be reduced further depending on imaging chain configuration

**PRO C.225**  
**PRO C.320**  
**PRO C.450**



- ✓ Proven through many worldwide installations
- ✓ Flexibility due to many features like C-arm
- ✓ Large inspection envelope
- ✓ Adaptable configurations possible due to many versatile options

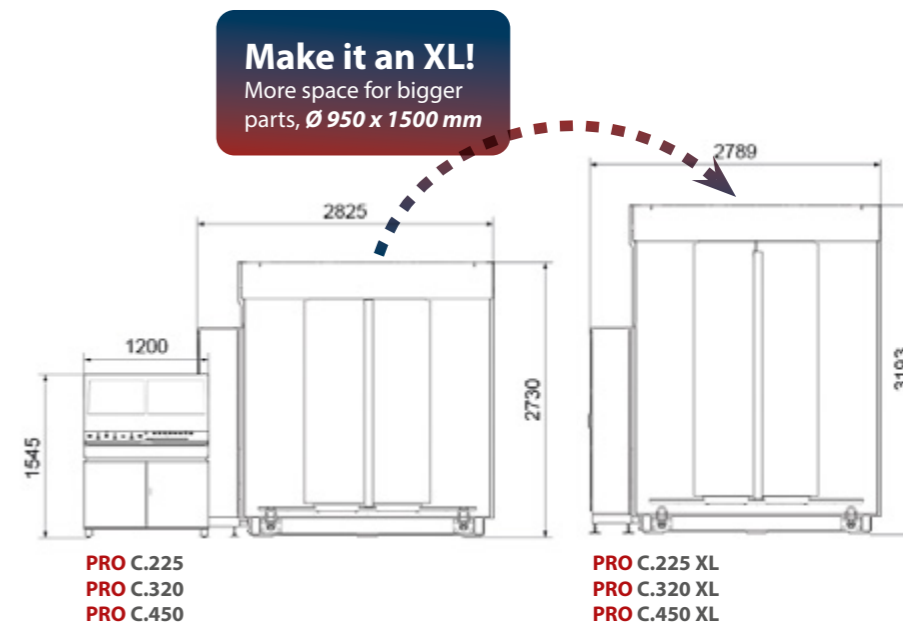

The PRO C line is one of our most popular X-ray solutions for medium to large sized parts, and its robustness is a tribute to its German engineering and production. This 7+ axis, 2-piece C-arm manipulator concept can be configured in a variety of ways – enabling the user the flexibility to inspect a wide variety of parts. The core of the system is VCxray's x.OS software ecosystem, and technologies like Computed Tomography (CT) and Automatic Defect Recognition (ADR) are especially effective due to the precise motion control and programming capability. Both the standard and XL versions of these cabinets are available in 225, 320, and 450kV versions.

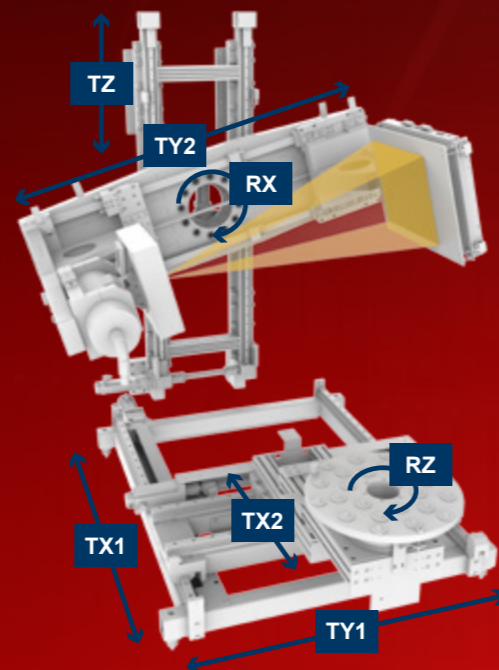

	<b>PRO C.225</b>	<b>PRO C.320</b>	<b>PRO C.450</b>
<b>Cabinet dimensions*</b>	2515x2825x2730 mm	2515x2825x2730 mm	2515x2825x2730 mm
<b>Inspection envelope</b>	Ø 650 x 900 mm	Ø 650 x 900 mm	Ø 650 x 900 mm
<b>Tilt axis (RX)**</b>	+/-30° max.	+/-30° max.	+/-30° max.
<b>Magnification value range</b>	1.3 - 3.1	1.3 - 3.1	1.3 - 3.1
<b>Max. part weight</b>	60 kg	600 kg	600 kg
<b>Energy</b>	225 kV	320 kV	450 kV

\*All dimensions are nominal and may vary depending on system configuration

\*\* Tilt is reduced continuously in the upper and lower positions and may be reduced further depending on imaging chain configuration

**PRO C.225 TL**  
**PRO C.320 TL**  
**PRO C.450 TL**



- ✓ Convenient handling and inspection of big, heavy and complex parts
- ✓ Clear digital radiography images including live enhancement
- ✓ Heavy duty part manipulator with ultra-precise axes
- ✓ Overhead loading via external crane

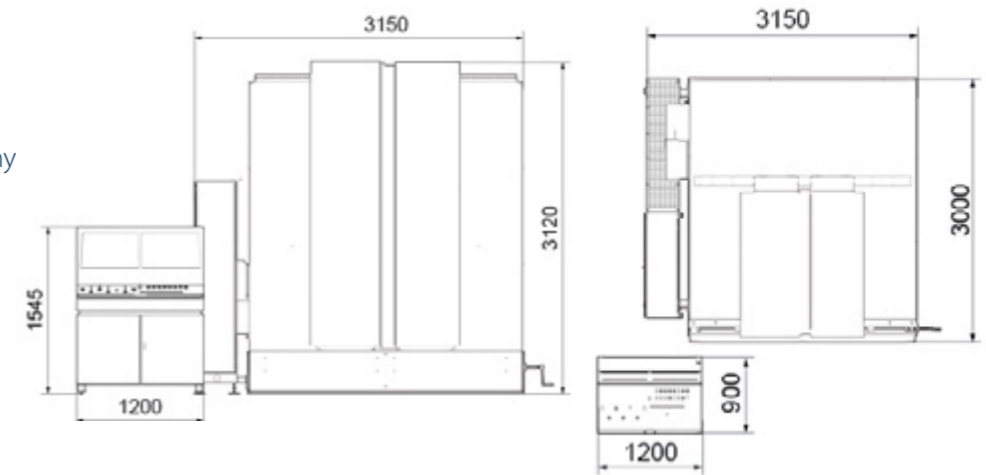

The TL version of our PRO C is designed specifically for very big and heavy parts (like steel castings) that require a more advanced loading concept. The VCxray approach allows the system to be loaded in a safe and efficient way by implementing a door concept that allows for overhead loading via crane. This design also facilitates the inspection of the heaviest parts due to the part manipulator not being required to be driven outside the cabinet for (un)loading. Precise CNC control enables high accuracy DR and CT inspections, and the easy programming makes the difficult inspection sequences much easier to implement.



**Part loading from above the cabinet**

	<b>PRO C.225 TL</b>	<b>PRO C.320 TL</b>	<b>PRO C.450 TL</b>
<b>Cabinet dimensions*</b>	3000 x 3120 x 3150mm	3000 x 3120 x 3150mm	3000 x 3120 x 3150mm
<b>Inspection envelope</b>	Ø 950mm x 1500mm	Ø 950mm x 1500mm	Ø 950mm x 1500mm
<b>Tilt axis (RX)**</b>	+/-30° max.	+/-30° max.	+/-30° max.
<b>Magnification value range</b>	1.4 - 3	1.4 - 3	1.4 - 3
<b>Max. part weight</b>	600 kg	600 kg	600 kg
<b>Energy</b>	225 kV kV	320 kV	450 kV

\*All dimensions are nominal and may vary depending on system configuration

\*\* Tilt is reduced continuously in the upper and lower positions and may be reduced further depending on imaging chain configuration

## ► Comprehensive X-Ray Operating System

The x.OS is an innovative software ecosystem that is both comprehensive and configurable at the same time. This modular approach can be used as separate offline applications or can be configured as an interconnected online solution – and virtually everything in between.

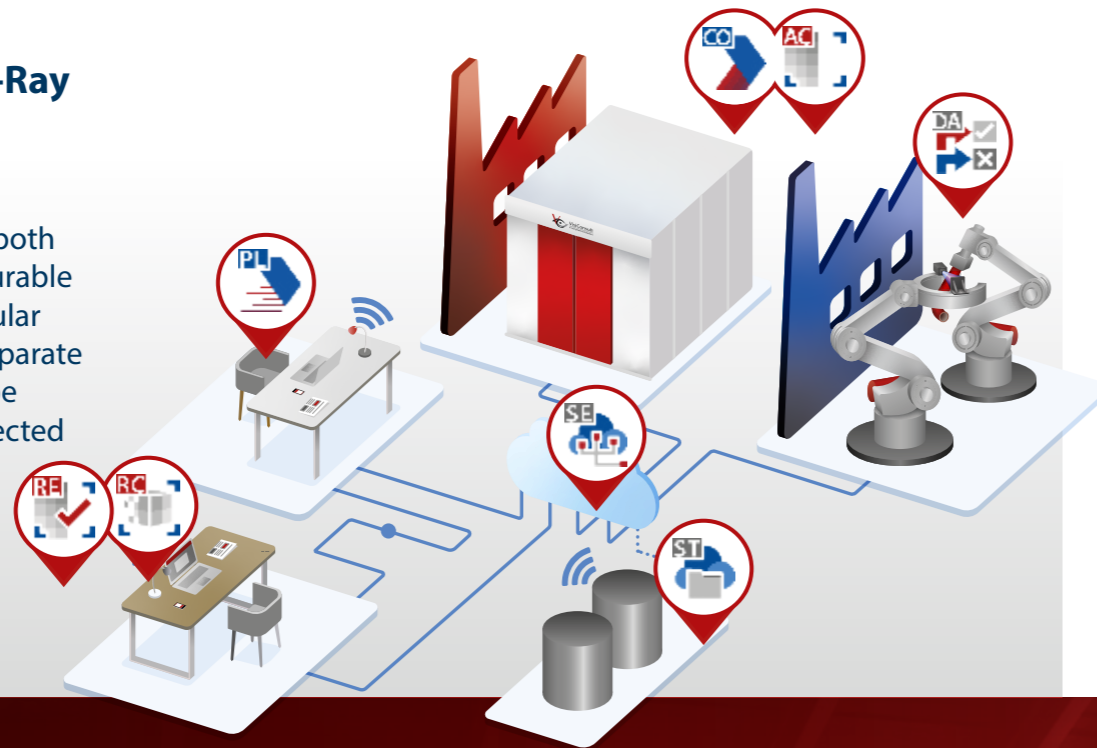

### **VC.control**

User-friendly software module to run or automate the X-ray system.

### **VC.acquire**

Versatile acquisition software for 2D X-ray images or 3D CT projections with many measurement and image processing features.

### **VC.planner**

Supervisors can easily develop or edit programs and techniques for their systems. They can perform it offline, and then send the new inspection programs to VC.control.

### **VC.review and VC.reco**

Evaluate and interpret the data directly via VC.reco for CT scans or VC.review for analyzing and interpreting 2D images.

### **VC.server & VC.storage**

Using the VC.server, the remote evaluation team can access all data within the VC.storage. It is the place to archive data for long-term storage.

### **VC.dashboard**

This module gives an overview about the status of the different inspection projects.

## ► Versatile hardware options

In addition to an outstanding range of X-ray sources and detectors, the PRO line offers versatile options. This allows you to flexibly adapt your system to your individual process. Whether filter reel or safety light curtain, choose your extras.

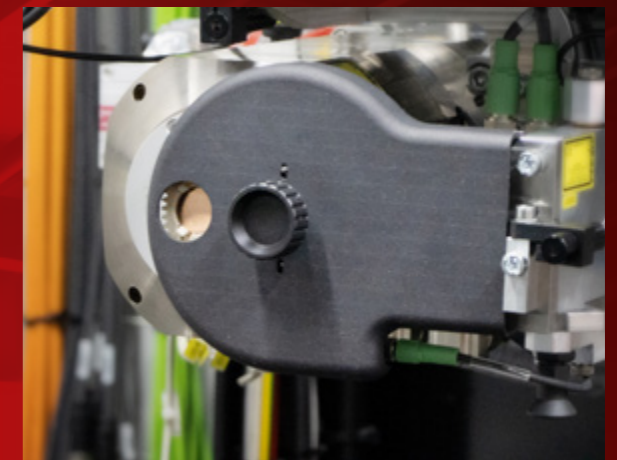

## ► Customized Cabinets

If your need can't be solved by one of our standard configurations or extensive options list, we also provide customized solutions. Contact us with a description of your challenge, and we will be happy to discuss a solution.

## ➤ Computed Tomography

- ✓ Dimensional Measurement and Reporting
- ✓ Assembly Verification and Visualization
- ✓ External and internal Measurement
- ✓ Form Analysis
- ✓ Defect Detection
- ✓ Fiber Flow Analysis
- ✓ Failure Analysis

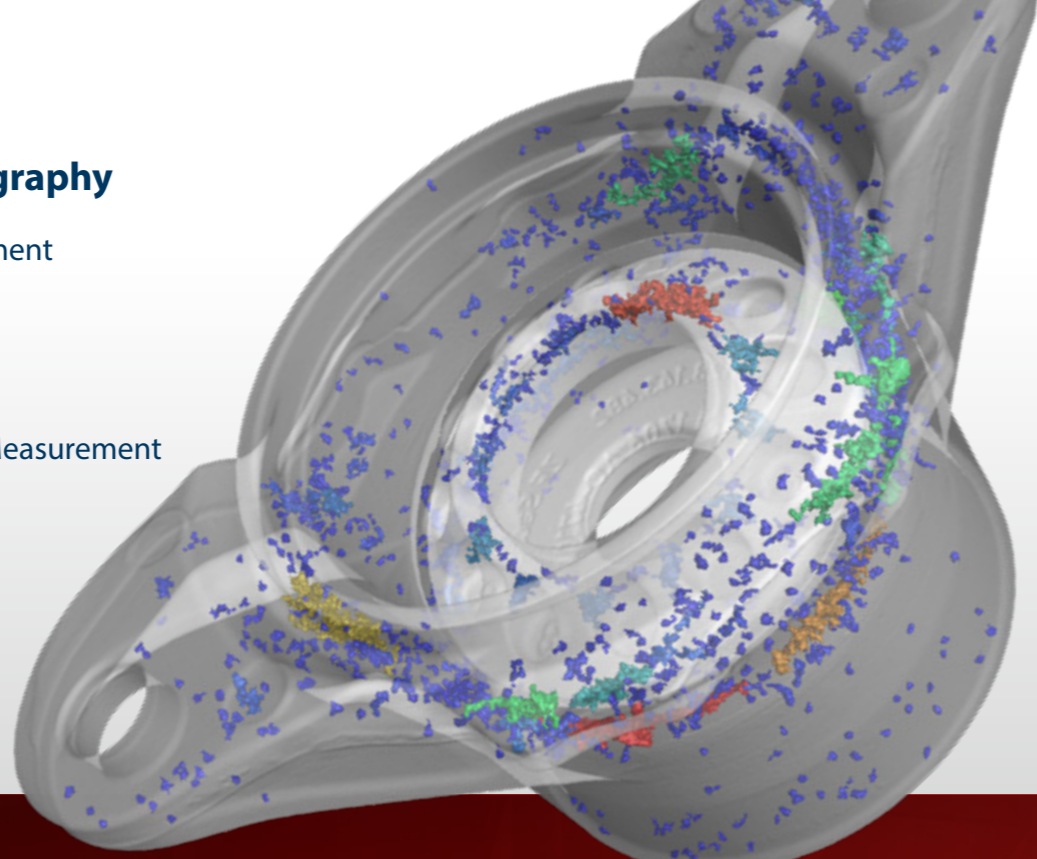

## ➤ Automated Defect Recognition (ADR)

- ✓ All PRO systems are ADR capable
- ✓ Allows to detect defects like porosities
- ✓ Including an ADR offline programming toolbox
- ✓ Evaluation criteria like defect size, defects per area, distance between defects etc. can be defined

## ➤ Smart Inspection with AI in NDT

The main task of AI in NDT applications is machine learning (ML), which means training algorithms to reliably solve complex pattern recognition tasks such as detecting a porosity. This requires a significant amount of labeled training data.

If you are interested in our AI pilot program, please contact us. We are looking forward to present you our first results.

Computed Tomography (CT) is a technology that allows 3D reconstruction of test parts. This allows advanced analyses of the error shape, position and distribution.

Often, classic digital radiography (DR) cannot deliver accurate depth information of defects in X-ray images. As it is a purely two-dimensional technology, anomalies can be detected but the depth and location of these discoveries can often not be accurately determined. Nevertheless, in some applications it is a big difference if the error is close to the surface or deep inside the part. Another interesting metric is the exact defect-volume, which is impossible to determine in 2D images. Depending on the application, various acquisition speeds, trajectory paths and even reconstruction techniques can be utilized.

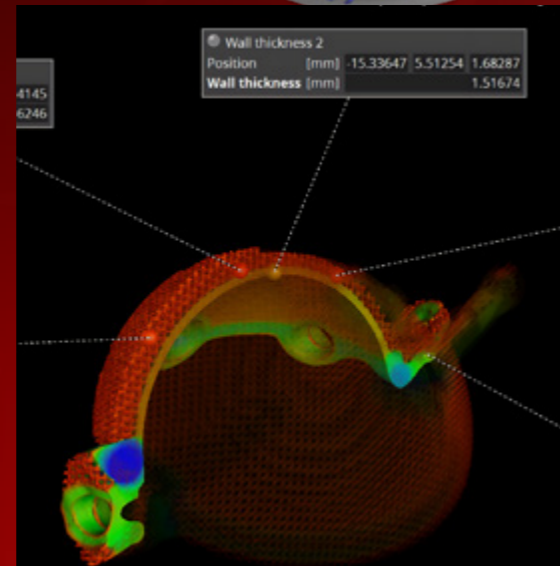

Automatic detection of defects through advanced image processing or Artificial Intelligence (AI) algorithms can offer significant savings. VisiConsult has over 25 years of experience in this field and has a comprehensive in-house developed ADR toolbox. It fulfills international quality standards like ASTM, as well as the demanding company standards in the automotive industry. Typical ADR applications include the detection of porosities, inclusions and cracks, as well as geometric measurements and feature recognition. It is possible to define specific ROIs to check many metrics like density, distance, size, occurrence per area and many more tools that can be dynamically defined – even via machine learning. The best ADR solution for your application may require traditional algorithms OR perhaps an AI solution will work – we can help you determine this.





## Regional headquarters

**EMEA**  
**Stockelsdorf, Germany**  
Tel: +49 451 290 286 0

**Americas**  
**Atlanta, US**  
Tel: +1 888 972 9821

**APAC**  
**Pune, India**  
Tel: +91 124 4048273

## Agent for the Benelux



**Opticon Benelux Naarden B.V.**  
**Kobaltstraat 5b**  
**1411 AM Naarden, Netherlands**  
Tel. +31 (0)35 6953991  
[info@opticonbnl.com](mailto:info@opticonbnl.com)



This document is non-contractual. Constant improvement and engineering progress make it necessary that we reserve the right to make specification, equipment, and price changes without notice. Illustrations shown may include optional equipment and accessories and may not include all standard equipment.  
September 2022

[info@visiconsult.de](mailto:info@visiconsult.de)  
[www.visiconsult.de](http://www.visiconsult.de)